

1 Introduction

The AirMedia® Presentation gateway delivers a simple, low-cost wireless HD presentation solution.

2 Hardware Hookup

Make the necessary connections as called out in the illustration below. When making connections to the AM-100, use Crestron® power supplies for Crestron equipment. Apply power after all connections have been made.

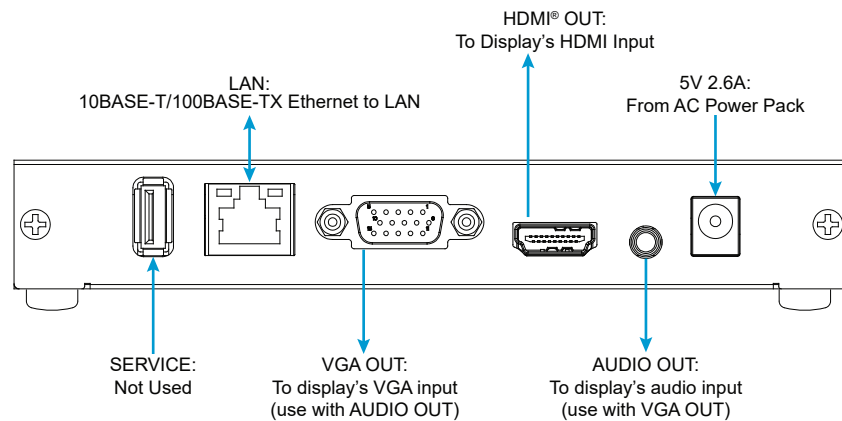

NOTE: Typical Installation uses only the HDMI OUT or the VGA OUT-AUDIO OUT connection.

3 Share a Presentation

This section provides instructions on sharing a desktop on a display device. For instructions on remotely viewing a shared desktop, refer to section 4.

Make all connections as described in the "Hardware Hookup" above. The connected display shows the AM-100 welcome screen.

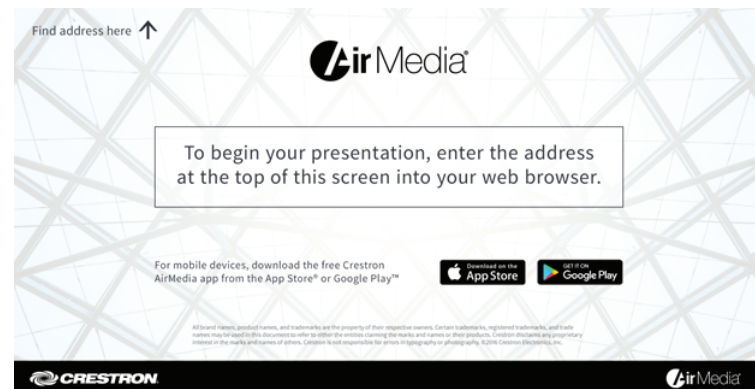

Download the Client Application

The AM-100 can use a client application to share a PC or a Mac (hereafter referred to as a "computer") desktop. The computer should be able to access the AM-100 over the network.

NOTE: Mobile devices can share content using the AirMedia for AM-100 app, which is available for iOS® and Android™ devices. Download the latest version from the App Store® app in iTunes® software or the Google Play™ store.

- On the computer, open a web browser, and navigate to the web address or IP address displayed on the top left of the AM-100 welcome screen. The download screen is displayed.

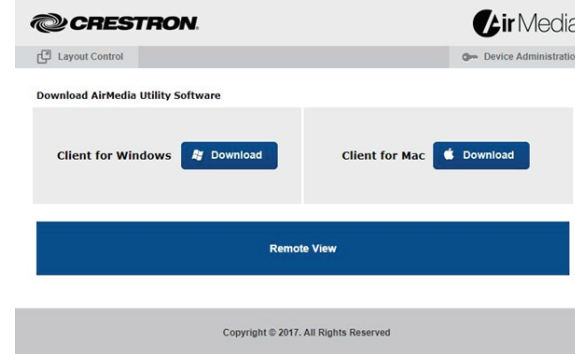

- Click the **Download** icon for the computer's operating system to download the client application. The client application requires no installation. The application can either be saved and run locally, or run from the Internet.

NOTE: When used on a Mac® computer, the AirMedia client application must be run from within the disk image file. Do not drag the application of the disk image file.

Share the Computer Desktop

- Run the client application. The **Enter Code (Enter Passcode on Mac)** screen is displayed.

Enter Code (L-R, Windows® and Mac)

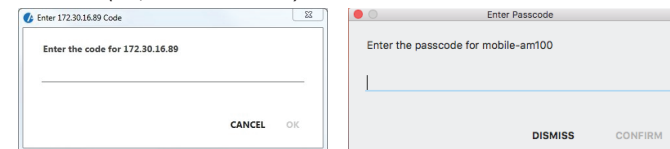

- Enter the code displayed on the AM-100 welcome screen, and click **OK (CONFIRM on Mac)**. The client establishes a connection between the the computer and the AM-100 while displaying the AirMedia controls on the computer.

Crestron AirMedia Controls (L-R, Windows and Mac)

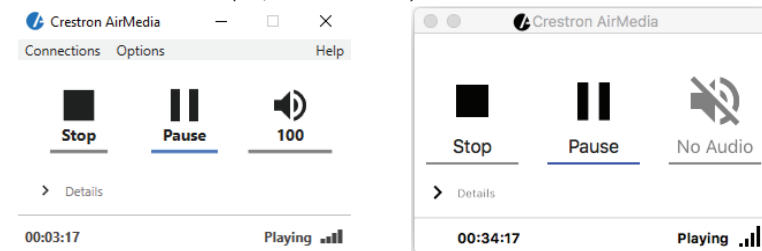

- Direct the presentation with the following controls:

- Click to stop showing the computer's screen.
- Click to start showing the computer's screen.
- Click to freeze the computer's screen.
- Hover over to show a volume slider control and drag the slider to raise or lower the volume.
- Click to mute the audio output.
- Click to unmute the audio output.

- Click to close the client application and the connection between the computer and the AM-100. On a Mac, click to close the client application and the connection between the computer and the AM-100.

- Click to minimize the presentation control screen. On a Mac, click to minimize the presentation control screen.

Other Functions

Click **Details** to control remote viewing and video performance. For details, refer to the AM-100 Operations Guide (Doc. 7643) at crestron.com/manuals.

4 View a Presentation Remotely

This section provides instructions on remotely viewing a shared desktop. For instructions on sharing a desktop, refer to "Share a Presentation."

If Remote View is enabled, audience members can view desktop images via the AM-100's built-in web server. Perform the following procedure to remotely view images:

- Open a web browser on a remote computer and navigate to the web address or IP address supplied by the user or users that are sharing their desktops. The download screen is displayed.

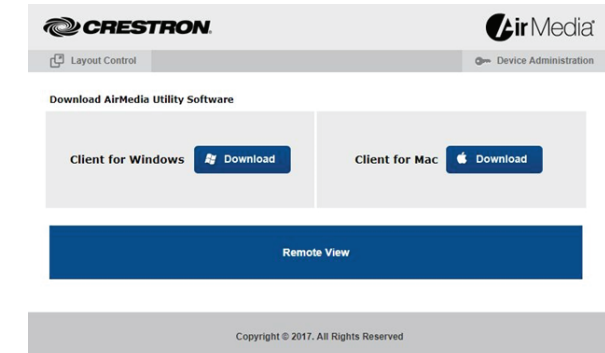

- Click **Remote View**. The shared desktop is displayed in the web browser as a web page.

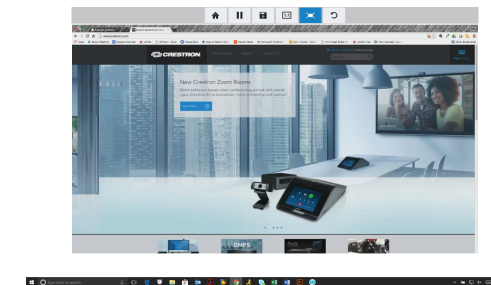

- Use the following buttons when viewing the AM-100's output in a web browser.

- Exit remote viewing and return to the download screen.
- Pause the currently displayed image.
- Save the currently displayed image.
- View the currently displayed image at actual size.
- View the currently displayed image at full-screen size.
- Refresh the image.

For details, refer to the AM-100 Operations Guide, Doc 7463.

QUICKSTART DOC. 7464E (2036013) 12.17

The specific patents that cover Crestron products are listed at patents.crestron.com.

Certain Crestron products contain open source software. For specific information, please visit www.crestron.com/opensource.

Crestron, the Crestron logo, and AirMedia are either trademarks or registered trademarks of Crestron Electronics, Inc. in the United States and/or other countries. App Store, iTunes, and Mac are either trademarks or registered trademarks of Apple Inc. in the United States and/or other countries. IOS is either a trademark or registered trademark of Cisco Technology, Inc. in the United States and/or other countries. Android and Google Play are either trademarks or registered trademarks of Google Inc. in the United States and/or other countries. HDMI is either a trademark or registered trademark of HDMI Licensing LLC in the United States and/or other countries. Windows is either a trademark or registered trademark of Microsoft Corporation in the United States and/or other countries. Other trademarks, registered trademarks, and trade names may be used in this document to refer to either the entities claiming the marks and names or their products. Crestron disclaims any proprietary interest in the marks and names of others. Crestron is not responsible for errors in typography or photography.

This document was written by the Technical Publications department at Crestron.